

冲模零件 Punching Parts



冲模零件
Punching Parts

硬质合金零件
Carbide Parts

磨床附件
Accessories

工具附件
Tooling Tools

磨床磨棒
Grinding Wheel

电子检测仪器
Electronic Test Instrument

A型沖頭

A Type Punch

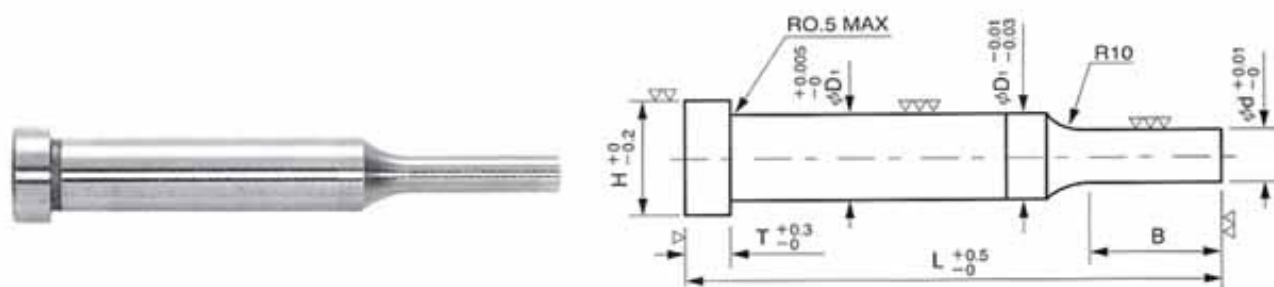

材質Material: SKD-11 硬度 Hardness: HRC60° ~ 62° 單位Unit:mm

製品代號 Item No.	D ₁	切口d		全長L			B	H	T
				40	50	60			
A4	4	1.0	1.1~1.4	○	○	○	6	6	4
		1.5	1.6~2.4				8		
		2.5	2.6~3.4				10		
A5	5	2.0	2.1~2.4	○	○	○	8	7	4
		2.5	2.6~3.4				10		
		3.5	3.6~4.4				12		
A6	6	2.5	2.6~3.4	○	○	○	10	8	4
		3.5	3.6~4.4				12		
		4.5	4.6~5.4				15		
A8	8	5.0	5.1~7.9	○	○	○	15	10	5
A10	10	8.0	8.2~9.8		○	○	15	12	5
A13	13	10.0	10.2~12.8		○	○	15	15	5
A16	16	13.0	13.5~15.5		○	○	15	18	5
A20	20	16.0	17.0~19.0		○	○	15	22	5
A25	25		20		○	○	15	28	5

- ◆ 採購代號 製品代號 D_1 - d × L 數量 例：A 6-4.0×50 L 10支
 特殊材質：SKH-9、ASP-23、ASP-60、鎢鋼
 交貨時間：特殊材質5-7天，SKD-11材質2-4天
 訂製時請說明材質之類別

- ◆ Purchasing code: Item No. D_1 - d × L Q'ty
 Example: A 6 - 4.0×50L 10pcs
 Special material: SKH-9, ASP-23, ASP-60 & CARBIDE
 Delivery time: 5-7 days for special material, 2-4 days for SKD-11.
 Please specify material when ordering.

B型引導沖頭

B Type Guide Punch

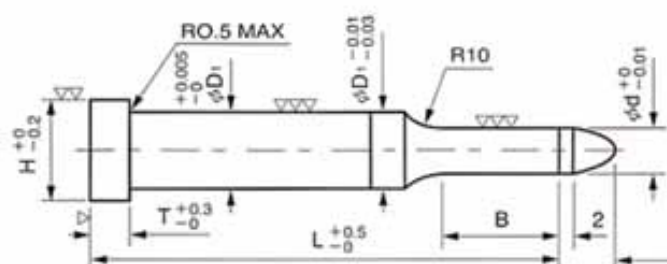

材質Material: SKD-11 硬度 Hardness: HRC60° ~ 62° 單位Unit:mm

製品代號 Item No.	D ₁	導口d	全長L			B	H	T
			41	51	61			
B4	4	1.5 1.6~2.4	○	○	○	8	6	4
		2.5 2.6~3.4				10		
B5	5	2.0 2.1~2.4				8	7	4
		2.5 2.6~3.4	○	○	○	10		
		3.5 3.6~4.4				12		
B6	6	3.0 3.1~3.4				10	8	4
		3.5 3.6~4.4	○	○	○	12		
		4.5 4.6~5.4				15		
		5.5 5.6~5.9				15		
B8	8	6.0 6.1~7.9		○	○	15	10	5
B10	10	8.0 8.2~9.8		○	○	15	13	5

◆ 採購代號 製品代號 $D_1 - d \times L$ 數量 例: B 5-3.2×51 L 10支

特殊材質: SKH-9、ASP-23、ASP-60、鎢鋼

交貨時間: 特殊材質5-7天, SKD-11材質2天

訂製時請說明材質之類別

導口d的尺寸在5.0以上時, 引導部的長為 $d \times 1.2$, d在5.0以下時, 引導部的長為5mm。

◆ Purchasing code: Item No. $D_1 - d \times L$ Q'ty

Example: B 5-3.2×51L 10pcs

Special material: SKH-9, ASP-23, ASP-60 & CARBIDE

Delivery time: 5-7days for special material, 2-4days for SKD-11.

Please specify material when ordering.

When $d > 5.0$ mm, the guide length is $d \times 1.2$; when $d < 5.0$ mm, the guide length is 5mm.

D型突緣沖頭(抽孔沖頭)

D Type Flange Punch

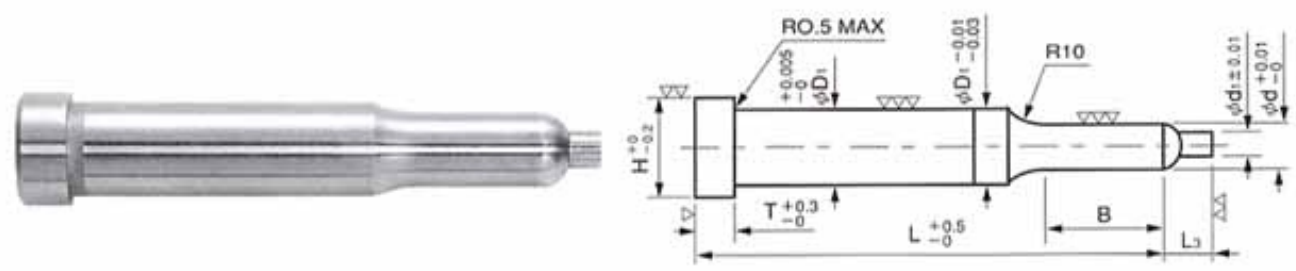

材質Material: SKD-11 硬度 Hardness: HRC60° ~ 62° 單位Unit:mm

製品代號 Item No.	D ₁	d	全長 L			B	H	T	L ₃	d ₁	牙種
			41	51	61						
D5	5	1.65	○	○		6	7	4	3.0	1.0	M2.0
		2.2	○	○		8	7	4	3.0	1.3	M2.6
		2.5	○	○	○	10	7	4	3.0	1.5	M3.0
		2.6	○	○	○	10	7	4	3.0	1.5	M3.0
D6	6	2.2	○	○	○	8	8	4	3.0	1.3	M2.6
		2.5	○	○	○	10	8	4	4.0	1.5	M3.0
		2.6	○	○	○	10	8	4	4.0	1.5	M3.0
		2.75	○	○	○	10	8	4	4.0	1.6	M3.0
		3.1	○	○	○	10	8	4	4.0	1.9	6#/32
		3.7	○	○	○	10	8	4	4.0	1.9	M4.0
D8	8	4.3		○	○	12	8	4	5.0	2.4	M5.0
		5.2		○	○	15	10	5	5.0	2.6	M6.0

◆ 採購代號 製品代號 $D_1 - d \times L$ 數量 例：D 6-2.6×51 L 10支

特殊材質：SKH-9、ASP-23、ASP-60、鎢鋼

交貨時間：特殊材質5-7天，SKD-11材質2-4天

訂製時請說明材質之類別

◆ 以上表內牙種與尺寸d之間的關係，系經業者使用多年的經驗配合。
上訂尺寸均能適用各種攻牙作業。

◆ Purchasing code: Item No. $D_1 - d \times L$ Q'ty

Example: D 6-2.6×51L 10pcs

Special material:SKH-9,ASP-23,ASP-60 & CARBIDE

Delivery time:5-7days for special material,2-4days for SKD-11

Please specify material when ordering.

◆ The above specified threads applied to the d dimensions were developed through many years by the manufacturer ensure and accurate threading.

H型沖頭

H Type Punch

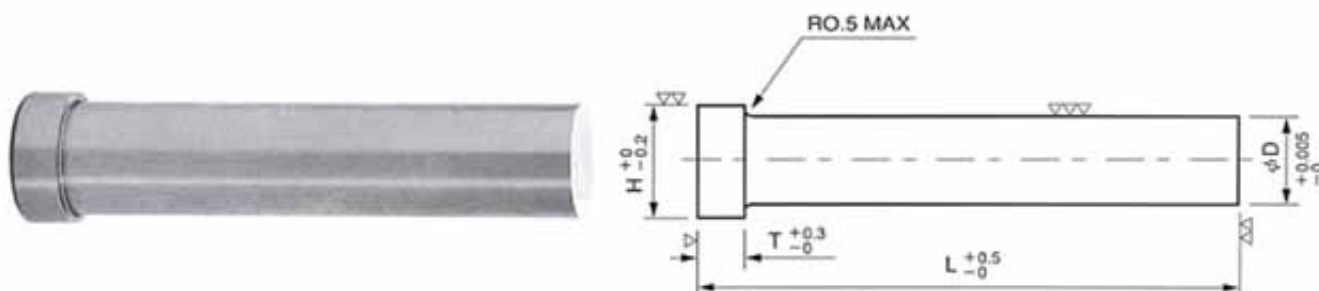

材質Material: SKD-11 硬度 Hardness: HRC60° ~ 62° 單位Unit:mm

製品代號 Item No.	D	全長L				H	T
		40	50	60	70		
H	1.0-1.2	○	○	○	○	2	4
	1.3-1.5	○	○	○	○	2.5	
	1.6-2.2	○	○	○	○	3	
	2.3-2.5	○	○	○	○	3.5	
	2.6-2.9	○	○	○	○	4	
	3.0-3.5	○	○	○	○	5	
	3.6-4.5	○	○	○	○	6	
	4.6-5.5	○	○	○	○	7	
	5.6-6.5	○	○	○	○	8	
	6.6-7.5	○	○	○	○	9	
	7.6-7.9	○	○	○	○	10	
	8.0-8.5	○	○	○	○	11	
	8.6-9.0	○	○	○	○	12	
	9.1-9.5	○	○	○	○	13	
	9.6-9.9	○	○	○	○	14	
	10.0-11.5	○	○	○	○	15	
	11.6-12.0	○	○	○	○	16	
	12.1-12.5	○	○	○	○	17	
	12.6-13.0	○	○	○	○	18	
	13.5&14.0	○	○	○	○	19	
	14.5&15.0	○	○	○	○	20	
	15.5&16.0	○	○	○	○	22	
	16.5&17.0	○	○	○	○	24	
	17.5&18.0	○	○	○	○	26	
	18.5&19.0	○	○	○	○	28	
	19.5&20.0	○	○	○	○		
	20.5&21.0	○	○	○	○		
	21.5&22.0	○	○	○	○		
22.5&23.0	○	○	○	○			
23.5&24.0	○	○	○	○			
24.5&25.0	○	○	○	○			
25.5&26.0	○	○	○	○			

◆ 採購代號 製品代號 D × L 數量 例：H 4.0 × 50 L 10支

特殊材質：SKH-9、ASP-23、ASP-60、鎢鋼

交貨時間：特殊材質5-7天，SKD-11材質2天，訂製時請說明材質之類別

◆ Purchasing code: Item No. D × L Q'ty Example: H 4.0 × 50L 10pcs

Special material: SKH-9, ASP-23, ASP-60 & CARBIDE

Delivery time: 5-7days for special material, 2-4days for SKD-11.

Please specify material when ordering.

HC圓錐型沖頭

Conical Head Punches (Form D)

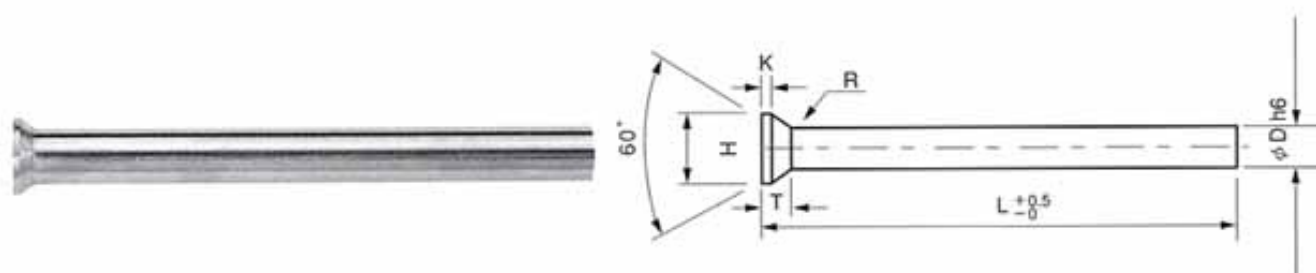

材質Material: SKD-11 硬度 Hardness: HRC60°~62° 單位Unit:mm

製品代號 Item No.	D h6	L ^{+0.5} ₋₀	H ±0.05	step	K +0.2 0	製品代號 Item No.	D h6	L ^{+0.5} ₋₀	H ±0.05	step	K +0.2 0
HC	0.90-0.95	60	1.6	0.05	0.4	HC	9.50-10.40	70	12.0	0.10	1.0
	1.00-1.10	70	1.8				10.50-11.40	80	13.0		
	1.15-1.30	80	2.0				11.50-12.40	90	14.0		
	1.35-1.50	90	2.2				12.50-13.40	100	15.0		
	1.55-1.70	100	2.5				13.50-14.40	110	16.0		
	1.75-1.90	110	2.8				14.50-15.00	120	17.0		
	1.95-2.00	120	3.0				15.10-16.00	130	18.0		
	2.05-2.20	130	3.2				16.50-17.00	140	19.0		
	2.25-2.50	140	3.5				17.50-18.00	150	20.0		
	2.55-2.95	150	4.0				18.50-19.00	160	21.0		
	3.00-3.40	160	4.5				19.50-20.00	170	22.0		
	3.50-3.90	170	5.0				21.00	180	23.0		
	4.00-4.40	180	5.5				22.00	190	24.0		
	4.50-4.90	190	6.0				23.00	200	25.0		
	5.00-5.40	200	6.5				24.00	210	26.0		
	5.50-5.90	210	7.0				25.00	220	27.0		
	6.00-6.40	220	8.0				26.00	230	28.0		
	6.50-7.40	230	9.0				27.00	240	29.0		
7.50-8.40	240	10.0	28.00	250	30.0						
8.50-9.40	250	11.0	29.00	260	31.0						
			30.00	270	32.0						

- ◆ 採購代號 [製品代號] - [D] × [L] 數量 例：HC型沖頭 HC 2 × 80 L 10支
特殊材質：SKH-9、ASP-23、ASP-60、鎢鋼
交貨時間：3-5天，特殊材質5-7天，訂製時請說明材質之類別

- ◆ Purchasing code: [Item No.] - [D] × [L] Q'ty

Example: HC 2 × 80 L 10pcs

Special material: SKH-9, ASP-23, ASP-60 & CARBIDE

Delivery time: 3-5 days, 5-7 days for special material.

Please specify material when ordering.

AC圓錐型沖頭

Conical Head Punches (Form D)

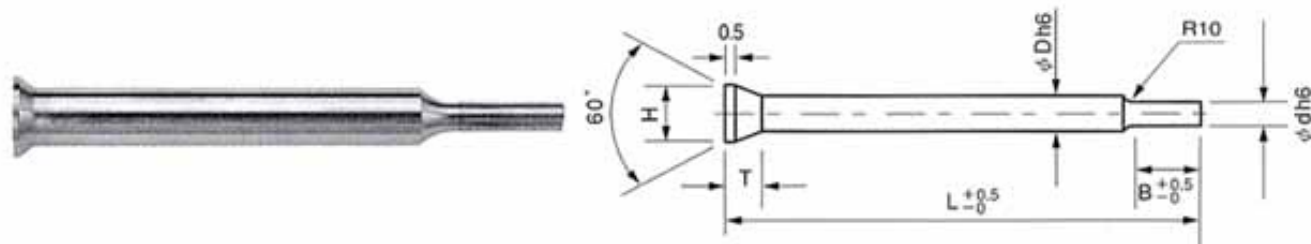

材質Material: SKD-11 硬度 Hardness: HRC60°~62° 單位Unit:mm

製品代號 Item No.	D			d	H	B	step
	h6	60	L ^{+0.5} ₋₀ 70 80				
AC	1.5		0.5-1.4	2.2±0.05	7	0.10	
	2.0		0.5-1.9	3.0±0.10	7	0.10	
	3.0		1.6-2.9	4.5±0.10	7	0.10	
	4.0		2.5-3.5	5.5±0.10	10	0.5	
	5.0		3.5-4.5	6.5±0.20	10	0.5	
	6.0		4.5-5.5	8.0±0.20	10	0.5	

◆ 採購代號 - × × 數量

例：AC型沖頭 AC 2.0 × 0.5 × 71 L 10支

特殊材質：SKH-9、ASP-23、ASP-60、錳鋼

交貨時間：特殊材質5-7天，SKD-11，3-5天

◆ Purchasing code: - × × Q'ty

Example: AC 2.0 × 0.5 × 71 L 10pcs

Special material: SKH-9,ASP-23,ASP-60 & CARBIDE

Delivery time: 5-7days for special material,3-5 days for SKD-11.

M型母模襯套

M Type Bushings (MA,MB 2 Types available)

MB



MA



MB

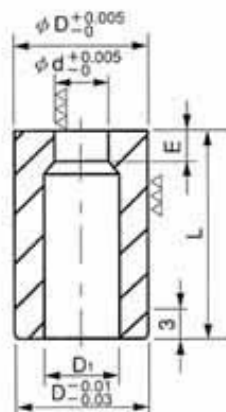

MA

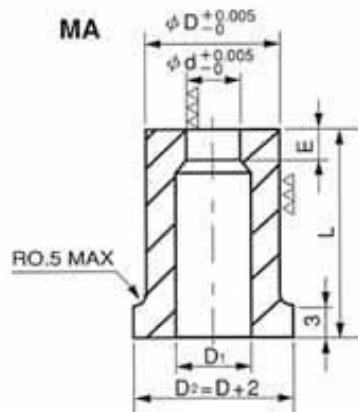

材質Material: SKD-11 硬度 Hardness: HRC60° ~ 62° 單位:Unit:mm

製品代號 Item No.	D	切口d	全長L			E	D ₁
			20	25	30		
MB	4	0.8~2.0				2	d + 0.3
	5	1.0~2.5					
	6	1.0~3.0					
	8	2.0~5.0				3	
	10	3.0~5.0					
	13	3.5~6.0					
	16	5.0~7.5				4	
MA	4	1.0~2.0				3	d + 0.3
	5	1.0~2.5					
	6	1.5~2.5					
	8	2.5~3.5				4	
	10	3.5~5.0					
	13	4.0~6.0					
	16	5.0~8.5				5	

◆ 採購代號 製品代號 $D - d \times L$ 數量 例：MA 10 - 3.0 × 25 L 10支

特殊材質：SKH-9、ASP-23、ASP-60、鎢鋼

交貨時間：特殊材質5-7天，SKD-11材質2天

訂製時請說明材質之類別

◆ Purchasing code: Item No. $D - d \times L$ Q'ty

Example: MA 10 - 3.0 × 25 L 10pcs

Special material: SKH-9, ASP-23, ASP-60 & CARBIDE

Delivery time: 5-7days for special material, 2days for SKD-11.

Please specify material when ordering.

* Above specs are all widely accepted and developed by the manufacturer.

按內浮昇兩用梢

Locating Pin

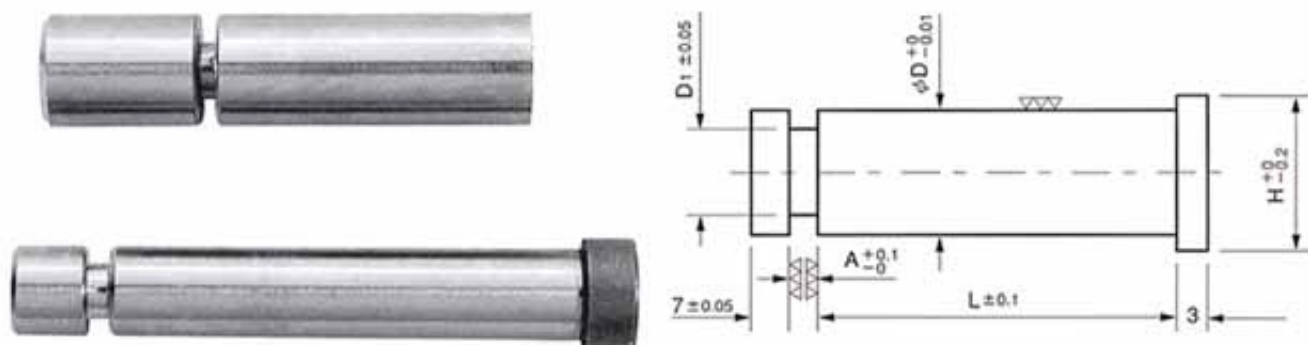

材質Material: SKD-11 硬度 Hardness: HRC60° ~ 62° 單位Unit:mm

製品代號 Item No.	D	L	A	D ₁	H
GLS	6	22 25 28 30 33 36	0.5 1.0 1.5	3.6	8
	8	25 28 30 33 36 40	1.0 2.0	5.0	10
	10	25 28 30 33 36 40 50	1.6 2.5	6.0	13
	13	28 30 33 36 40 50	2.5 3.6	7.0	16
	16	30 33 36 40 50 60	2.5 4.0	8.0	19

使用例Application Example:

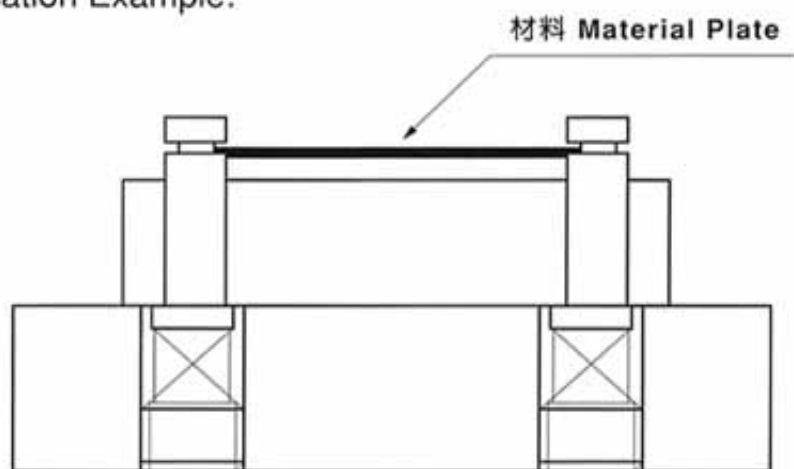

- ◆ 採購代號 製品代號 $D - A \times L$ 數量 例: GLS 8 - 1.0 × 30 L 10支
 - ◆ Purchasing code: Item No. $D - A \times L$ Q'ty
- Example: GLS 8 - 1.0 × 30 L 10pcs

等高套胴

Stripper Bolts

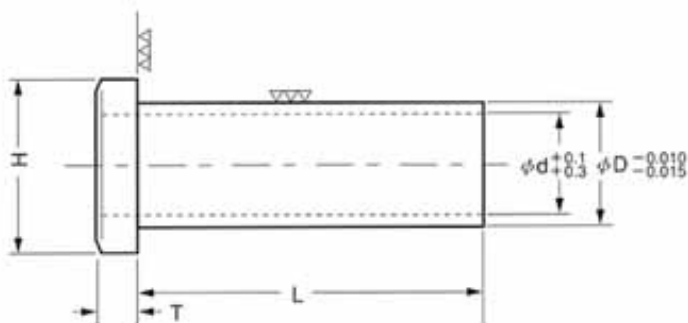

材質Material: S35C

硬度 Hardness: HRC42°

單位Unit:mm

製品代號 Item No.	L	d * D * H		
		6 * 9/13H	8 * 11/16H	10 * 13/18H
CSR	20	○	○	○
	25	○	○	○
	30	○	○	○
	35	○	○	○
	40	○	○	○
	45	○	○	○
	50	○	○	○
	55	○	○	○
	60	○	○	○
	65	○	○	○
	70	○	○	○
	80	○	○	○
	90	○	○	○
100	○	○	○	

◆ 採購代號 [製品代號] - [d] × [D] / [H] × [L] 數量

例：CSR - 8 × 11 / 16H × 50L 50支

交貨時間：2天

◆ Purchasing code: [Item No.] - [d] × [D] / [H] × [L] Q'ty

Example: CSR - 8 × 11 / 16H × 50L 50pcs

Delivery time: 2 days

固定剝料板用導引沖頭-直柱型

Pilot Punches Fixed In Stripper Plate



材質Material: SKD-11 硬度 Hardness: HRC60° ~ 62° 單位Unit:mm

製品代號 Item No.	L	D	A	Y	H
SPR	10.0~40.0	0.50~1.60	10°	2	2.6
	10.0~40.0	1.00~2.00		2	3
	10.0~40.0	1.50~2.50		2	3.5
	10.0~40.0	2.00~3.00		2	5
SPC	10.0~40.0	3.00~4.00	20°	2	7
	10.0~40.0	4.00~5.00	25°	3	8
SPA	10.0~40.0	5.00~6.00	30°	3	9
	10.0~40.0	6.00~8.00		5	11
	10.0~40.0	8.00~10.00		5	13

◆ 採購代號 - × 數量 例：SPR-2.0×40 L 10支
交貨時間：3天

◆ Purchasing Code: - × Q'ty
Example: SPR-2×40L 10pcs
Delivery time: 3 days

頂料梢

Lifter Pin

LPSA



LPSB

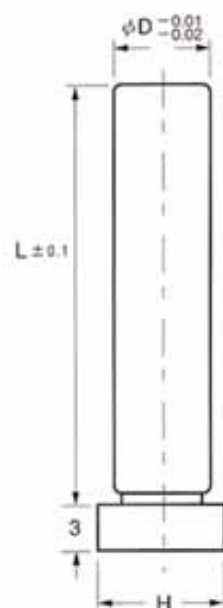
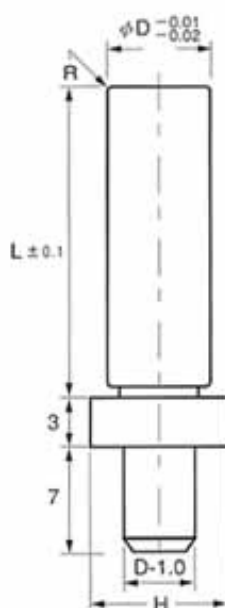

材質Material: S35C

硬度 Hardness: HRC40°

單位Unit:mm

製品代號 Item No.	L D	10	15	20	22	25	28	30	33	35	36	40
		LPSA	3,4	○	○	○	○	○	○	○	○	○
5,6	○		○	○	○	○	○	○	○	○	○	○
8	○		○	○	○	○	○	○	○	○	○	○
10	○		○	○	○	○	○	○	○	○	○	○
LPSB	3,4	○	○	○	○	○	○	○	○	○	○	○
	5,6	○	○	○	○	○	○	○	○	○	○	○
	8	○	○	○	○	○	○	○	○	○	○	○
	10	○	○	○	○	○	○	○	○	○	○	○

◆ 採購代號 - × 數量 例：LPSA 6 × 20L 30支

特殊材質：SKD-11、SKH-9

交貨時間：3天，特殊材質5-7天

◆ Purchasing code: - × Q'ty Example: LPSA 6 × 20L 30pcs

Special material: SKD-11,SKH-9

Delivery time: 3 days, 5-7days for special material.

特殊A型沖頭

Special Shoulder Punch

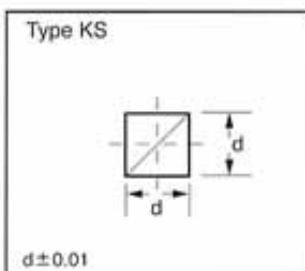
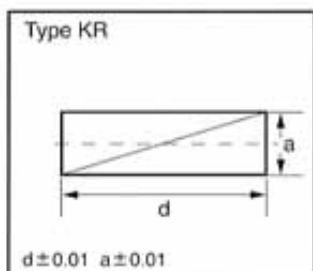
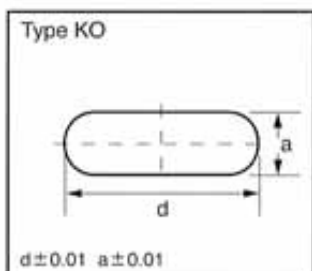
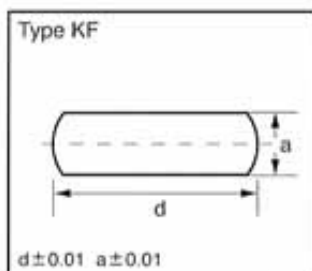
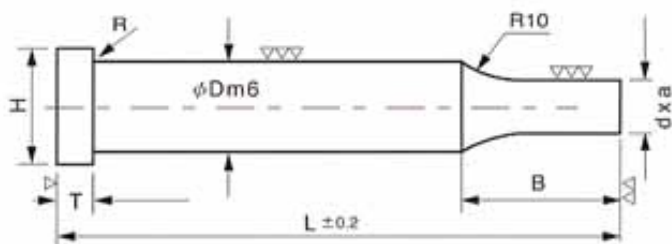

材質Material: SKD-11 硬度 Hardness: HRC60° ~ 62° 單位Unit:mm

製品代號 Type	D _{m6}	L ± 0.02				H -0.3	T +0.1	B ±0.5
		50	60	70	80			
KF	5.0					7.0	5.0	12.0
	6.0					9.0	5.0	13.0
	8.0					11.0	5.0	14.0
KO	10.0					13.0	5.0	16.0
	13.0					16.0	5.0	21.0
KR	16.0					19.0	6.0	24.0
	20.0					24.0	6.0	27.0
KS	25.0					31.0	10.0	32.0
	32.0					36.0	12.0	32.0
	38.0					45.0	15.0	36.0

- ◆ 採購代號 製品代號 $D \times d \times a \times L$ 數量 例: KF6.0×4×2×80L 10支
 特殊材質: SKH-9、ASP-23、ASP-60、鎢鋼
 交貨時間: 特殊材質5-7天, SKD-11材質2-4天
 訂製時請說明材質之類別

◆ Purchasing code: Item No. $D \times d \times a \times L$ Q'ty

Example: KF6.0×4×2×80L 10pcs

Special material: SKH-9, ASP-23, ASP-60 & CARBIDE

Delivery time: 5-7 days for special material, 2-4 days for SKD-11.

Please specify material when ordering.

固定梢

Dowel Pin

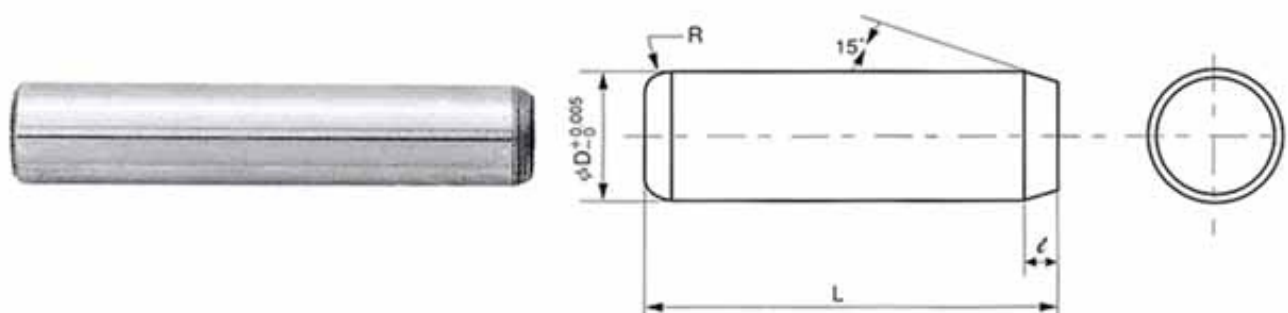

材質Material: S45C

硬度 Hardness: HRC58*

單位Unit:mm

製品代號 Item No.	L	3	4	5	6	8	D	10	12	13	14	16
LP	10	○	○	○	○		○					
	15	○	○	○	○	○	○		○			
	20	○	○	○	○	○	○		○			
	25	○	○	○	○	○	○		○			
	30	○	○	○	○	○	○		○	○		○
	35	○	○	○	○	○	○		○			○
	40	○	○	○	○	○	○		○	○	○	○
	45	○	○	○	○	○	○		○		○	○
	50	○	○	○	○	○	○		○	○	○	○
	55		○	○	○	○	○		○			○
	60		○	○	○	○	○		○	○	○	○
	65						○		○			○
	70		○	○	○	○	○		○	○	○	○
	75					○	○		○			○
	80					○	○		○	○	○	○
	90					○	○		○	○	○	○
	100					○	○		○	○	○	○
	110						○		○	○	○	○
120						○		○	○	○	○	
130											○	
140											○	
150											○	

◆ 採購代號 × 數量 例：LP 6×30 L 100支
交貨時間：2天，SKD-11材質3-5天

◆ Purchasing code: × Q'ty Example: LP 6×30 L 100pcs
Delivery time: 2days ,3-5days for SKD-11.

頂料(子母)沖頭 Shredder Punch

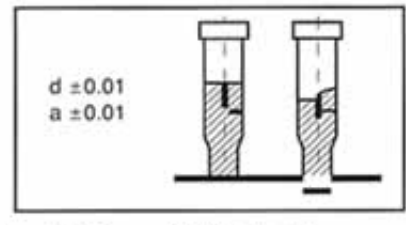
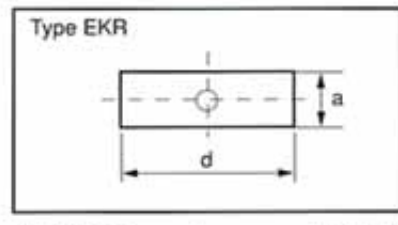
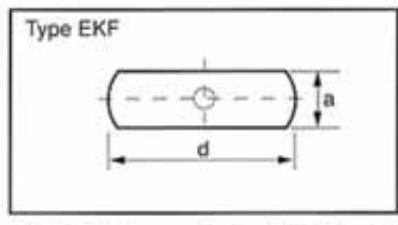
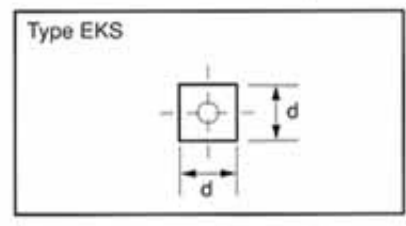
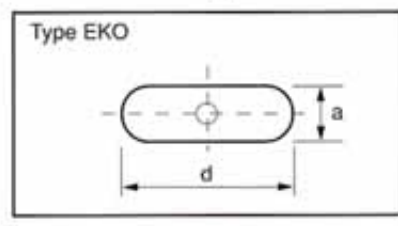
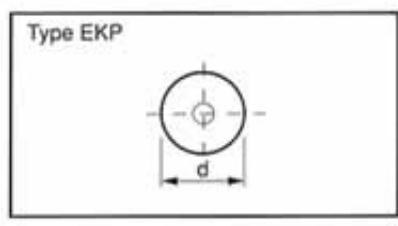
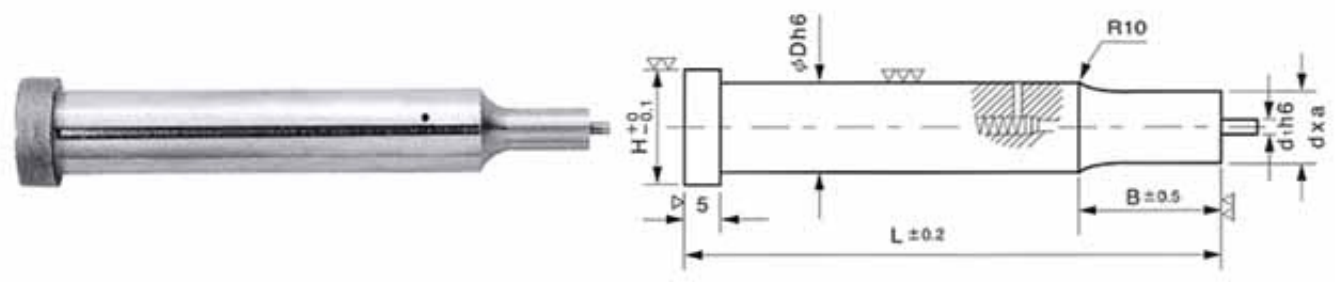

材質Material: SKD-11

硬度 Hardness: HRC60° ~ 62°

單位Unit:mm

製品代號 Type	D h6	L ± 0.2				H +0 -0.1	d1 h6	B ±0.5
		50	60	70	80			
EKP	5.0					7.0	1.0	12.0
	6.0					9.0	1.0	13.0
EKF	8.0					11.0	1.0	14.0
EKO	10.0					13.0	1.6	15.0
	13.0					16.0	1.6	21.0
EKR	16.0					19.0	2.0	24.0
EKS	20.0					23.0	2.0	27.0
	25.0					28.0	2.5	32.0

◆ 採購代號 製品代號 D × d × a × L 數量 例：EKO 8.0 × 6 × 2 × 80L 10支
 特殊材質：SKH-9、ASP-23、ASP-60、鎢鋼
 交貨時間：特殊材質5-7天，SKD-11材質3天
 訂製時請說明材質之類別

◆ Purchasing code: Item No. D × d × a × L Q'ty
 Example: EKO 8.0 × 6 × 2 × 80L 10pcs
 Special material: SKH-9, ASP-23, ASP-60 & CARBIDE
 Delivery time: 5-7 days for special material, 3 days for SKD-11.
 Please specify material when ordering.

脫料板輔助導柱

Stripper Guide Post

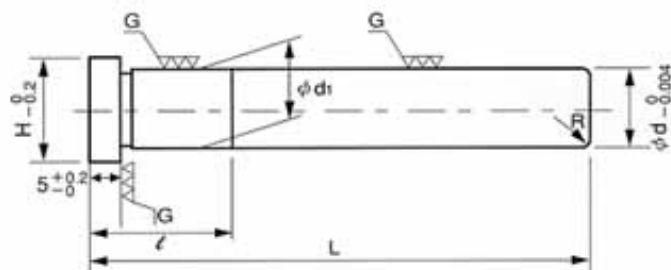

材質Material: SUJ-2

硬度 Hardness: HRC58°

單位Unit:mm

製品代號 Item No.	d	d1	H	ℓ	R	L											
						40	50	60	70	80	90	100	110	120			
SGPH	10	10.02 +0.012 +0.006	13	16	1.0	○	○	○	○								
	13	13.02 +0.015 +0.007	16	20	1.0		○	○	○	○	○						
	16	16.02 +0.015 +0.007	19	25	1.5			○	○	○	○	○					
	20	20.02 +0.017 +0.008	23	30	2.5				○	○	○	○	○	○			
	25	25.02 +0.017 +0.008	28	30	2.5					○	○	○	○	○			

◆ 採購代號 製品代號 - d × L 數量

例：SGPH 10×16 L 10支

交貨時間：3天

◆ Purchasing code: Item No. - d × L Q'ty

Example: SGPH 10×16 L 10pcs

Delivery time: 3 days

脫料板輔助導柱 Stripper Guide Post

SGPA

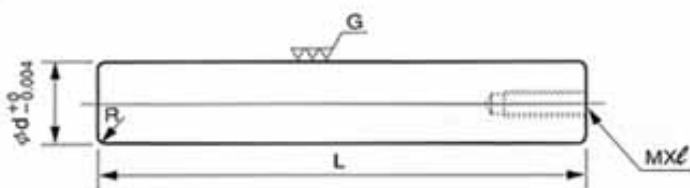

SGPC

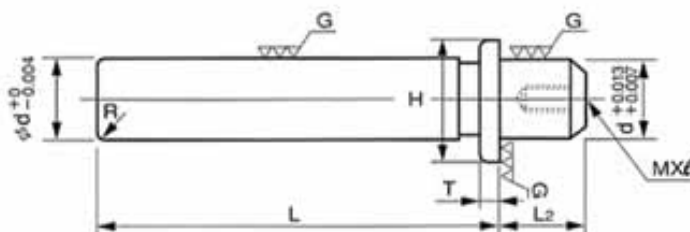

材質Material: SUJ-2 硬度 Hardness: HRC62±2 單位Unit:mm

製品代號 Type	d	R	Mxℓ	L ₂	H	T	L									
							40	50	60	70	80	90	100	110	120	
SGPA	10	1	M5×10	-	-	-	○	○	○	○						
	13	1	M5 M6	×	10	-	-	-		○	○	○	○	○		
	16	2	M5 M8	×	10	-	-	-			○	○	○	○	○	
	20	3	M6×12	-	-	-					○	○	○	○	○	○
	25	3	M6×12	-	-	-						○	○	○	○	○
SGPC	10	1	M5×10	10	15	4	○	○	○							
	13	1	M5×10	13	18	4	○	○	○	○	○					
	16	2	M5×10	16	22	4		○	○	○	○	○				
	20	3	M6×10	16	26	5			○	○	○	○	○	○	○	
	25	3	M6×10	20	31	6				○	○	○	○	○	○	

◆ 採購代號 - × 數量 例：SGPA 10×40L 20支
交貨時間：5天

◆ Purchasing code: - × Q'ty
Example: SGPA 10×40L 20pcs
Delivery time: 5 days

精密輔助導套

Stripper Guide Bushing

SGA



SGT

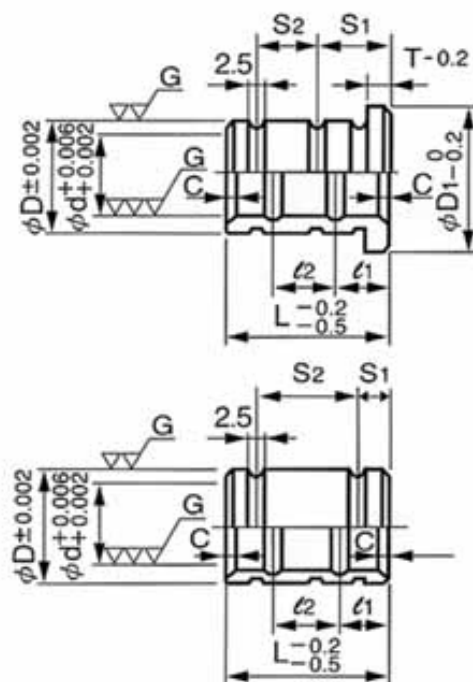

材質Material: SUJ-2 硬度 Hardness: HRC60° ~ 62° 單位Unit:mm

製品代號 Item No.	d	D	C	D ₁	T	L										
						13	15	19	20	22	25	30	35	40		
SGA	12	17	1.5	19	3T			○		○	○					
	13	18	1.5	23	4T	○	○		○		○					
	13	22	1.5	28	5T			○		○	○					
	14	19	1.5	21	3T			○		○	○					
	16	21	1.5	23	3T			○		○	○					
	16	22	1.5	27	4T			○			○	○	○			
	16	25	1.5	31	5T			○		○	○					
	20	26	2	31	4T				○			○	○	○	○	○
SGT	12	17	1.5	-	-			○		○	○					
	13	18	1.5	-	-	○	○		○		○					
	13	22	1.5	-	-			○		○	○					
	14	19	1.5	-	-			○		○	○					
	16	21	1.5	-	-			○		○	○					
	16	22	1.5	-	-		○		○		○	○	○			
	16	25	1.5	-	-			○		○	○					
	20	26	2	-	-				○			○	○	○	○	○

◆ 採購代號 製品代號 - [D] × [d] × [L] 數量

例：SGA18×13×15 L 10支

交貨時間：3天

◆ Purchasing code: [Item No.] - [D] × [d] × [L] Q'ty

Example: SGA18×13×15 L 10pcs

Delivery time: 3 days

輔助滾珠(滾柱)導柱導套

Guide Pillars & Guide Bushes

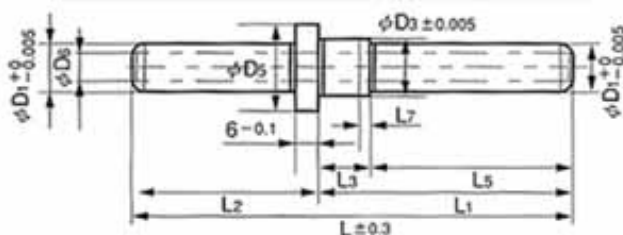

材質Material: SUJ-2 硬度 Hardness: HRC58°~60° 單位Unit:mm

製品代號 Item No.	D ₁	D ₃	D ₅	D ₆	L	L ₁	L ₂	L ₃	L ₅	L ₇	PURCHASING CODE D ₁ ×L ₁ ×L ₂
SGP	16	17	22	-	140	80	60	16	64	5	16×080×060
					150	90	60		74		16×090×050
					160	90	70		74		16×090×070
					170	100	70		84		16×100×070
					180	100	80		84		16×100×080
					190	100	90		84		16×100×090
	19	20	25	-	160	90	70	20	70	5	19×090×070
					170	100	70		80		19×100×070
					180	100	80		80		19×100×080
					190	110	80		90		19×110×080
					200	110	90		90		19×110×090
					210	110	100		90		19×110×100

◆ 交貨時間：5-7天

◆ Delivery time:5-7 days

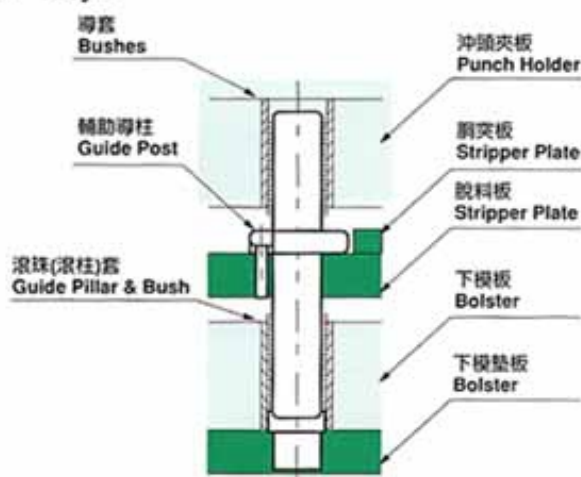
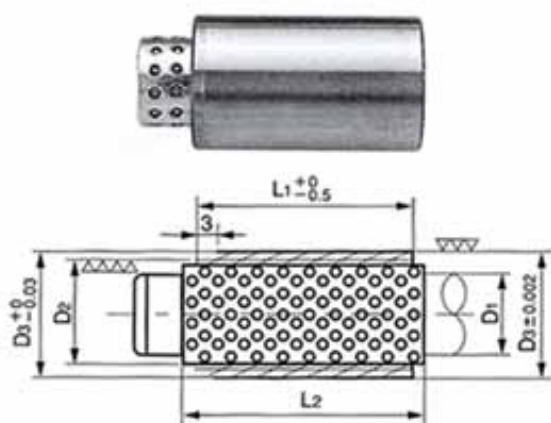

材質Material: SUJ-2 硬度 Hardness: HRC58°~60° 單位Unit:mm

製品代號 Item No.	D ₁	D ₂	D ₃	L ₁	L ₂	PURCHASING CODE D ₁ ×L ₁ ×L ₂
SGB	16	22	28	23	30	16×023×030
				30	38	16×030×038
				37	43	16×037×043
				47	54	16×047×054
				60	63	16×060×063
	19	25	32	23	30	19×023×030
				30	38	19×030×038
				37	43	19×037×043
				47	54	19×047×054
				60	63	19×060×063

◆ 交貨時間：5-7天

◆ Delivery time:5-7 days

精密導柱座

Precision Fixed Guide Rod Set

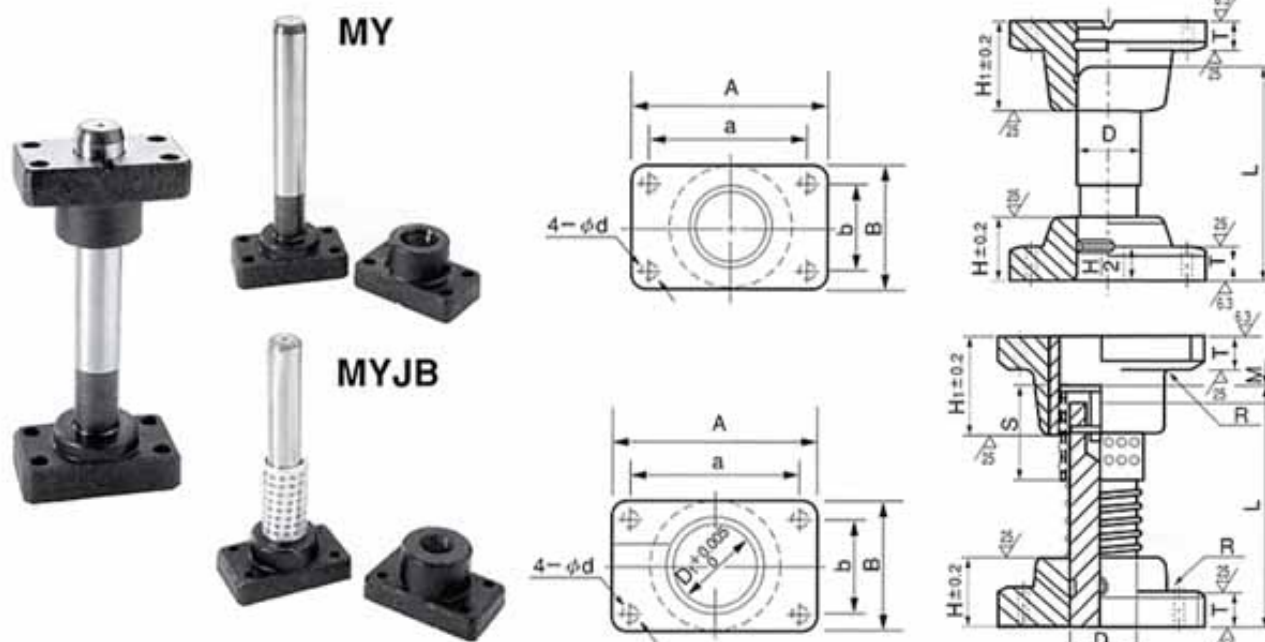

材質Material: S45C + FC250 硬度 Hardness: HRC55° 單位Unit:mm

製品代號 Item No.	D	A	B	a	b	d	H	H ₁	T
MY MYJB	25	84	48	66	30	9	30	45	20
	32	100	58	76	36	11	40	50	20
	38	130	75	100	44	11	50	60	25
	50	155	90	125	60	14	65	85	25
	60	190	120	150	80	18	75	100	30
	80	230	150	180	110	22	100	130	35

製品代號 Item No.	L															
	80	90	100	110	120	130	140	150	160	170	180	200	220	250	280	300
MY MYJB	○	○	○	○	○	○	○	○	○	○	○	○				
	○	○	○	○	○	○	○	○	○	○	○	○	○			
					○	○	○	○	○	○	○	○	○	○		
									○	○	○	○	○	○		
												○	○	○	○	○
														○	○	○

◆ 採購代號 製品代號 - D × L 數量 例：MY25 × 180 L 50組
交貨時間：5-7天

◆ Purchasing code: Item No. - D × L Q'ty
Example: MY25 × 180L 50sets
Delivery time: 5-7days